

Bring quality water into every micro-detail of life.

ERDEN AT886MS Microbubble Elf — Your Smart Water Upgrade Solution for the Home.



Is water that looks clean truly purifying? Traditional water flow can't reach microscopic hidden spots.



Pesticides and dirt in deep crevices:
Difficult for plain water to remove.



To remove oil, large amounts of
chemical detergents are used,
creating residual risks.



Water flow impact is too powerful,
countertop can never stay dry.

A Zero-Power Physical Miracle: Pure, Yet Incredibly Powerful.

AT886MS Core Components Revealed.

Dual Purification

Precision Filter Mesh
(Blocks Impurities, Refines Bubbles)



Robust and Durable

#304 Stainless Steel & Food-Grade PP Materials.

Innovation Driven

Pure Physical Air Suction Technology
(Zero Power, No Consumables, No Secondary Pollution)

ULTIMATE MICROSCOPIC SCALE FOR DEEP PORE PENETRATION.

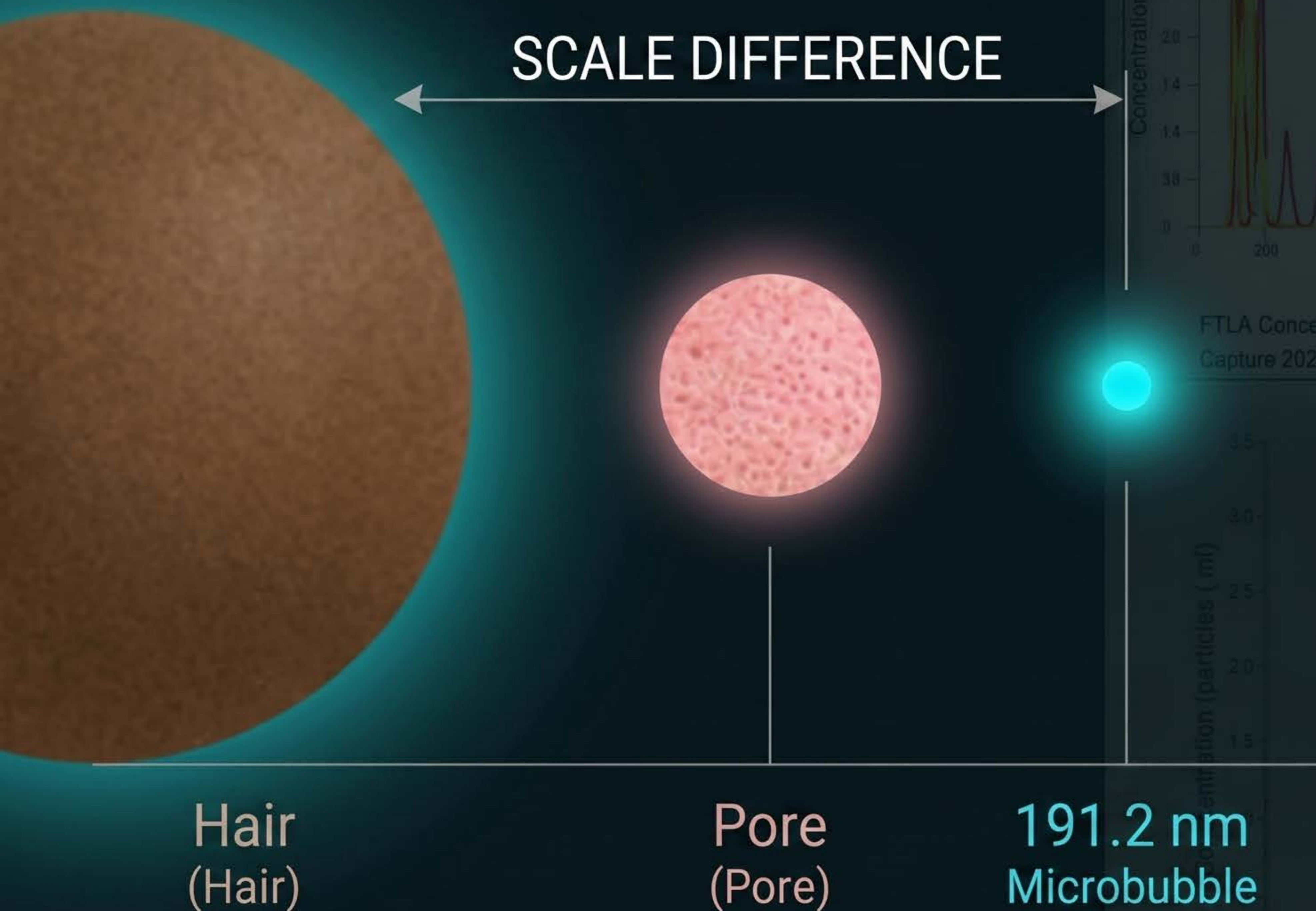

191.2 nm

AUTHORITATIVE DETECTION OF AVERAGE PARTICLE SIZE, HUNDREDS OF TIMES SMALLER THAN HUMAN BODY PORES.

1.5 BILLION UNITS

EACH MILLILITER (ml) OF WATER CONTAINS UP TO 153-216 MILLION CLEANSING SPIRITS.

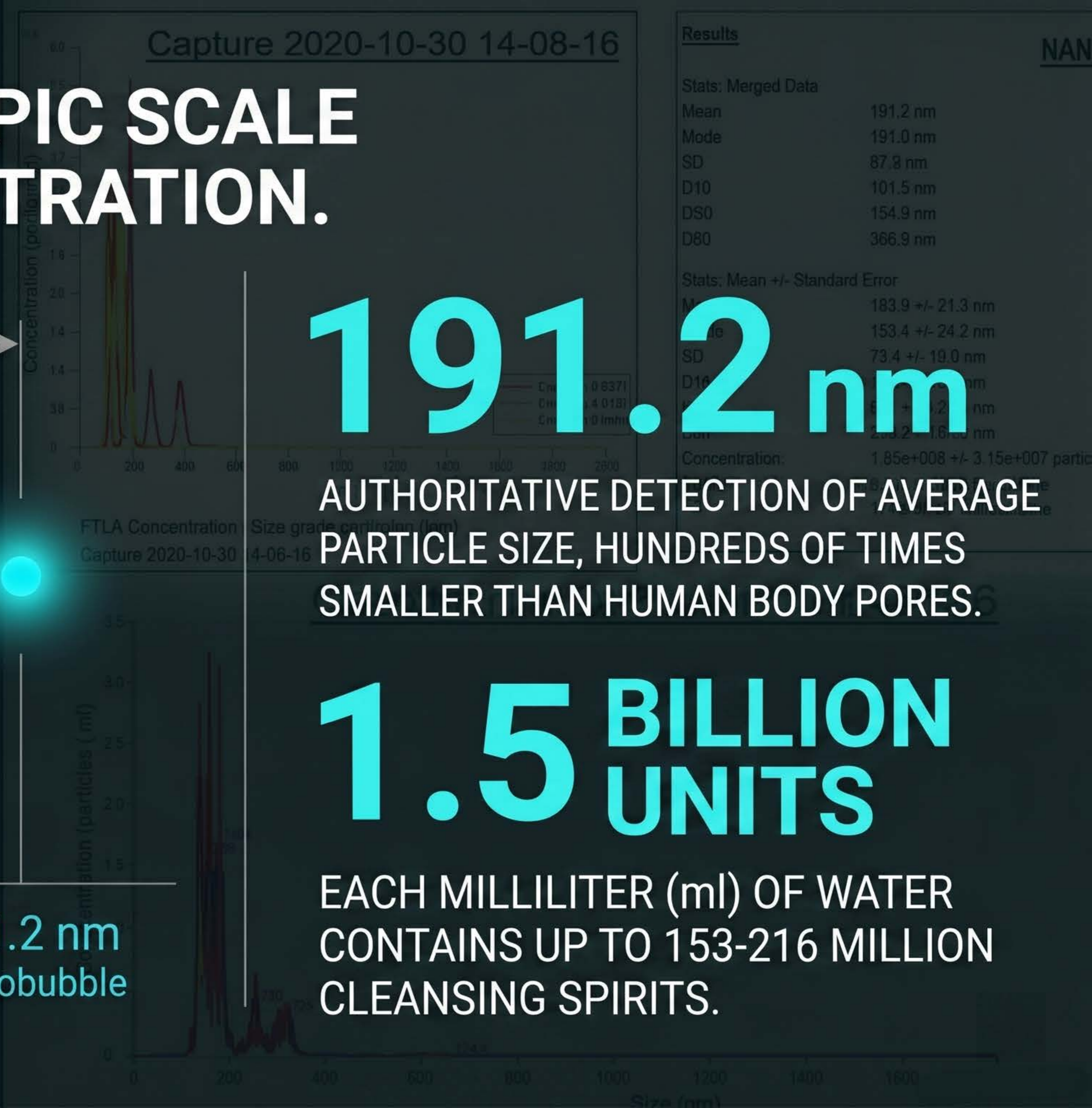

Visible Bubbles, Hidden Grime.

Standard Aerator

→ Large, easily burst bubbles.
Transparent & colorless.



Microbubble Cleanser

→ Hundreds of millions of dense,
suspended nano-sized bubbles.

Why does the water look milky?

This is the pure effect of light refraction by high-density microbubbles. No chemical additives. Letting it sit for a few minutes will make it gradually clear up from the bottom, returning it to its original pure water state.

A Gentle Touch, Say Goodbye to Messy Splashing.

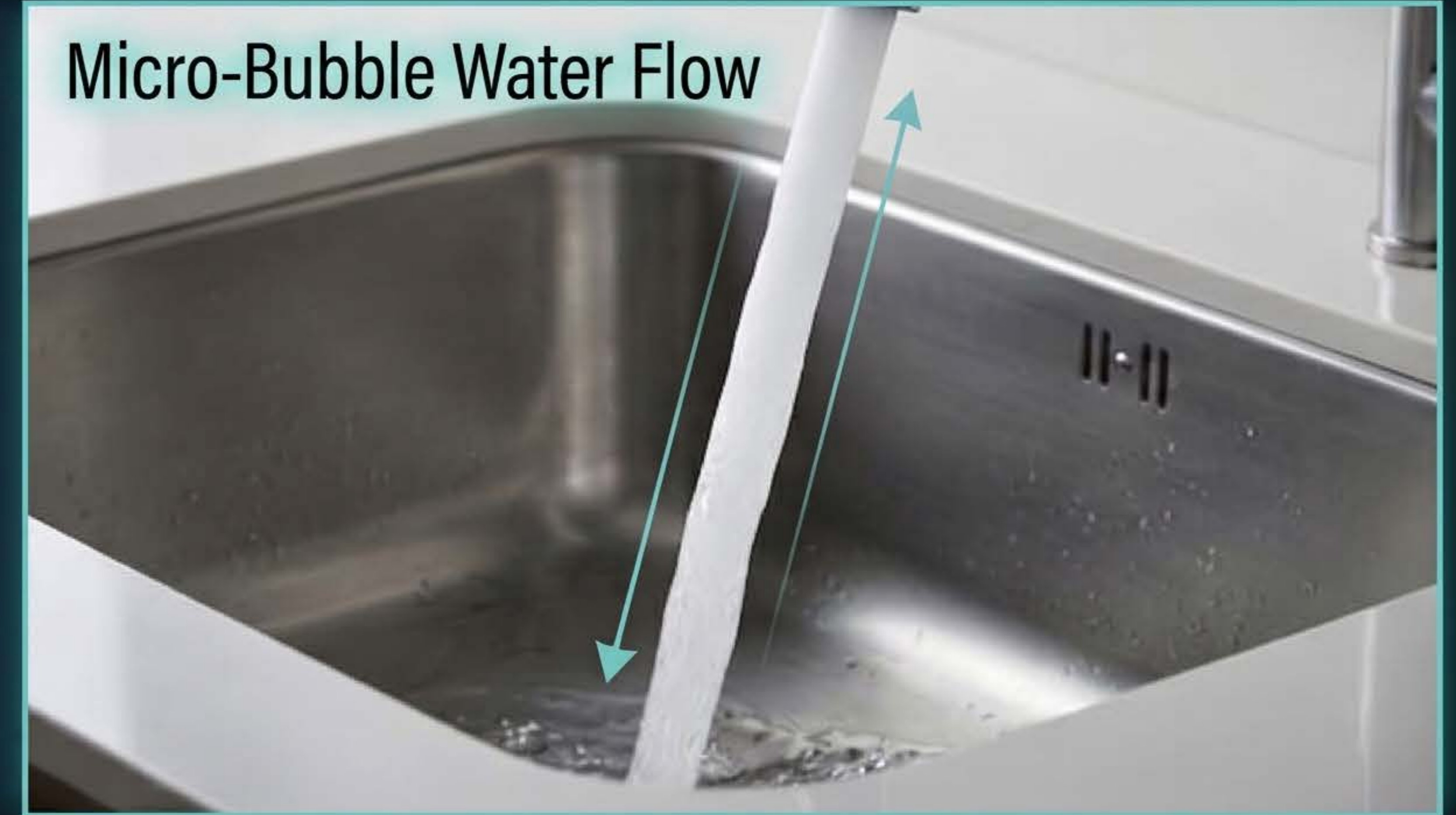

Traditional Water Flow

Excessive Force → Slippery Wet Surfaces, More Housework.

Micro-Bubble Water Flow

Dense & Fine → Reduced Splashes, Keeps Surfaces Dry.

Every Hand Wash Feels Like a Gentle Micro-SPA.

DEEP STRIPPING: The Physical Nemesis of Grease and Pesticides.

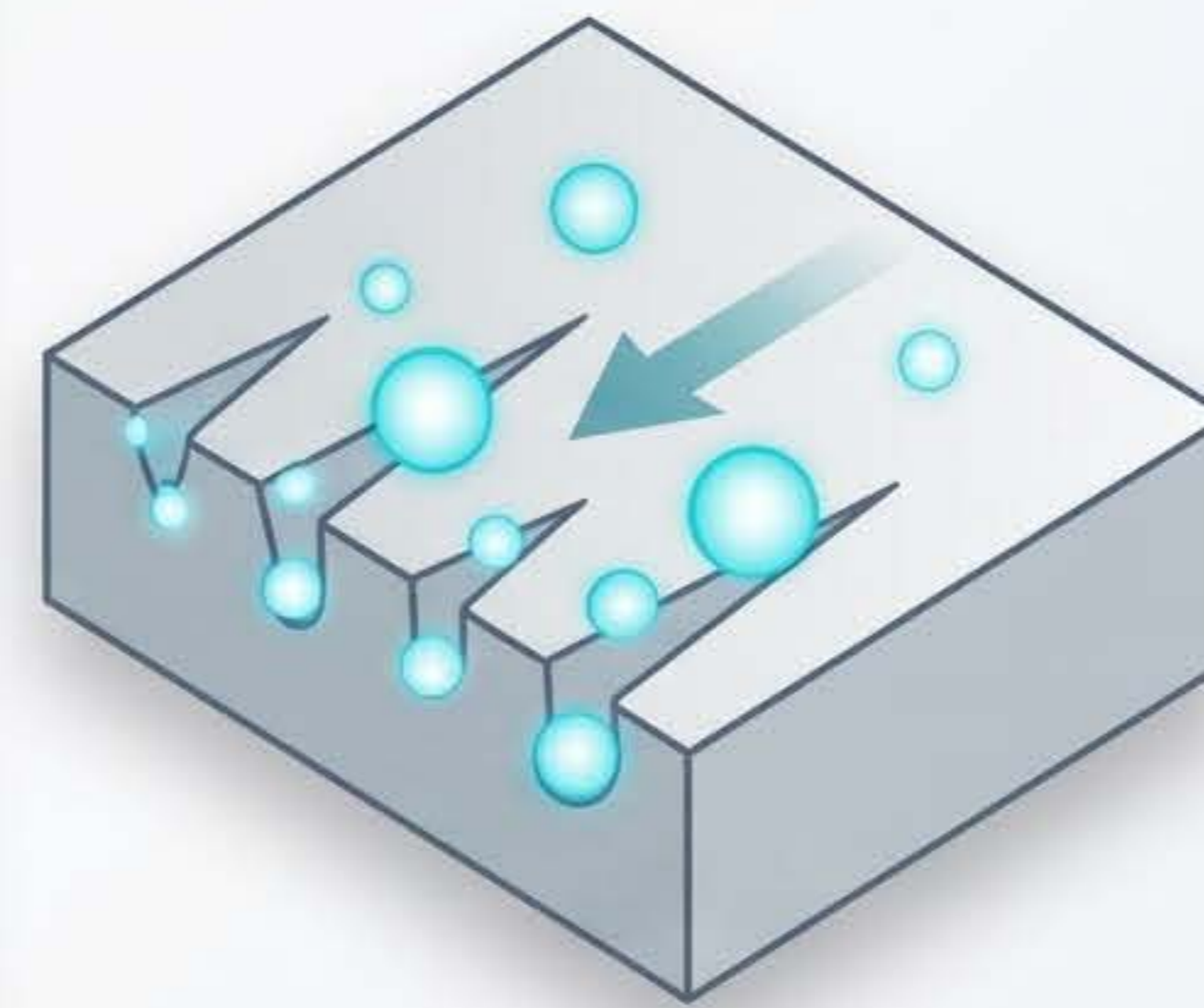

1 Deep Penetration

Nano-bubbles bore into recesses of produce and fine lines of tableware.



2 Adsorbing Contaminants

Bubble surface tension encapsulates grease, sediment, and pesticides.

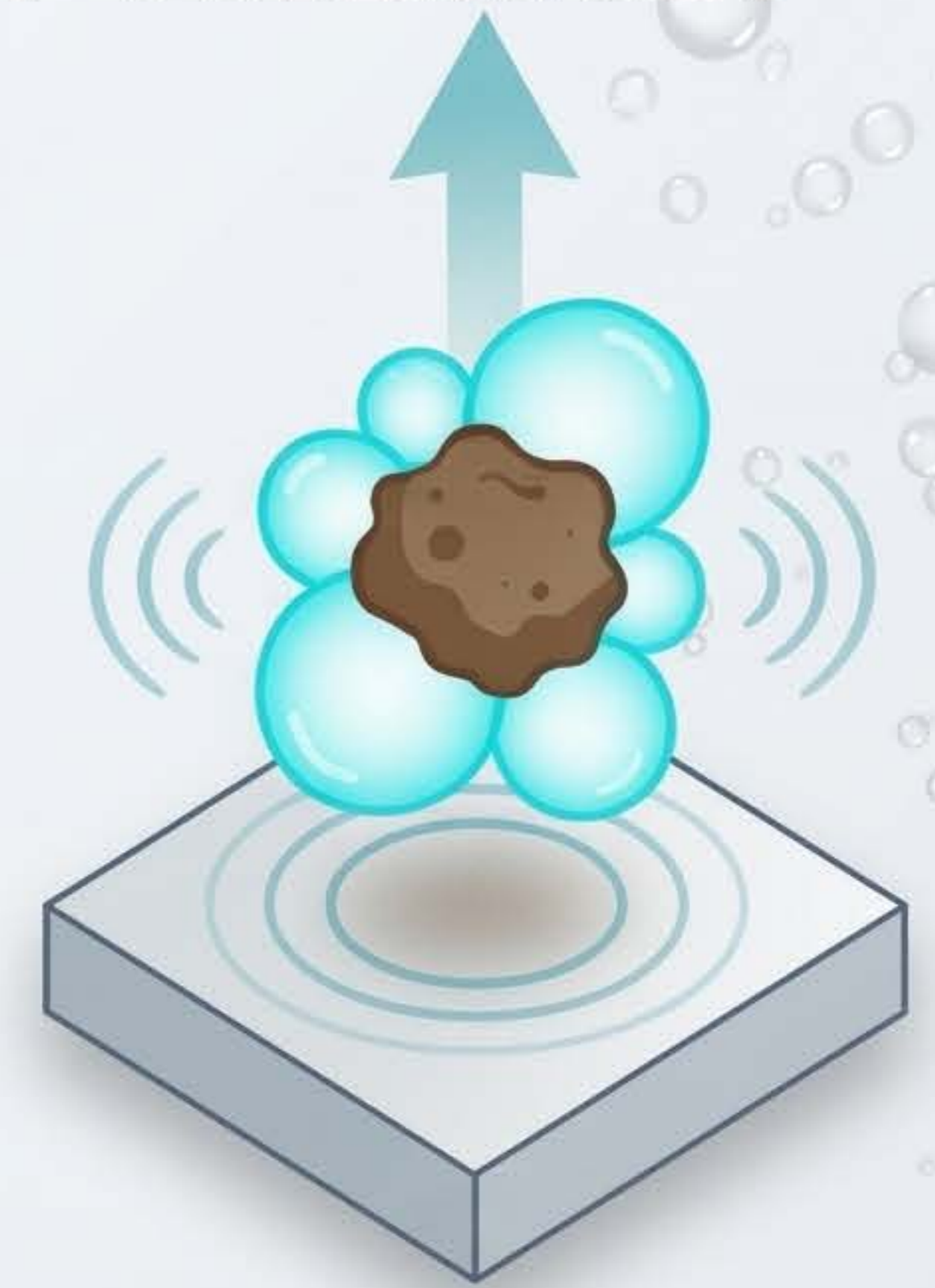

3 Effective Grime Removal

Instant micro-bubble collapse generates micro-waves to physically strip and carry away residues.

**Greatly Reduces Dish Detergent Usage,
Entirely Bids Farewell to Chemical Residues,
and Ensures Safer Family Dining.**

GREEN ECONOMY: THE WIN-WIN SOLUTION WITH NO LOSS IN PERCEIVED VOLUME.

A large volume of micro-bubbles occupies the water flow, increasing the contact area and "Perceived Volume Richness".

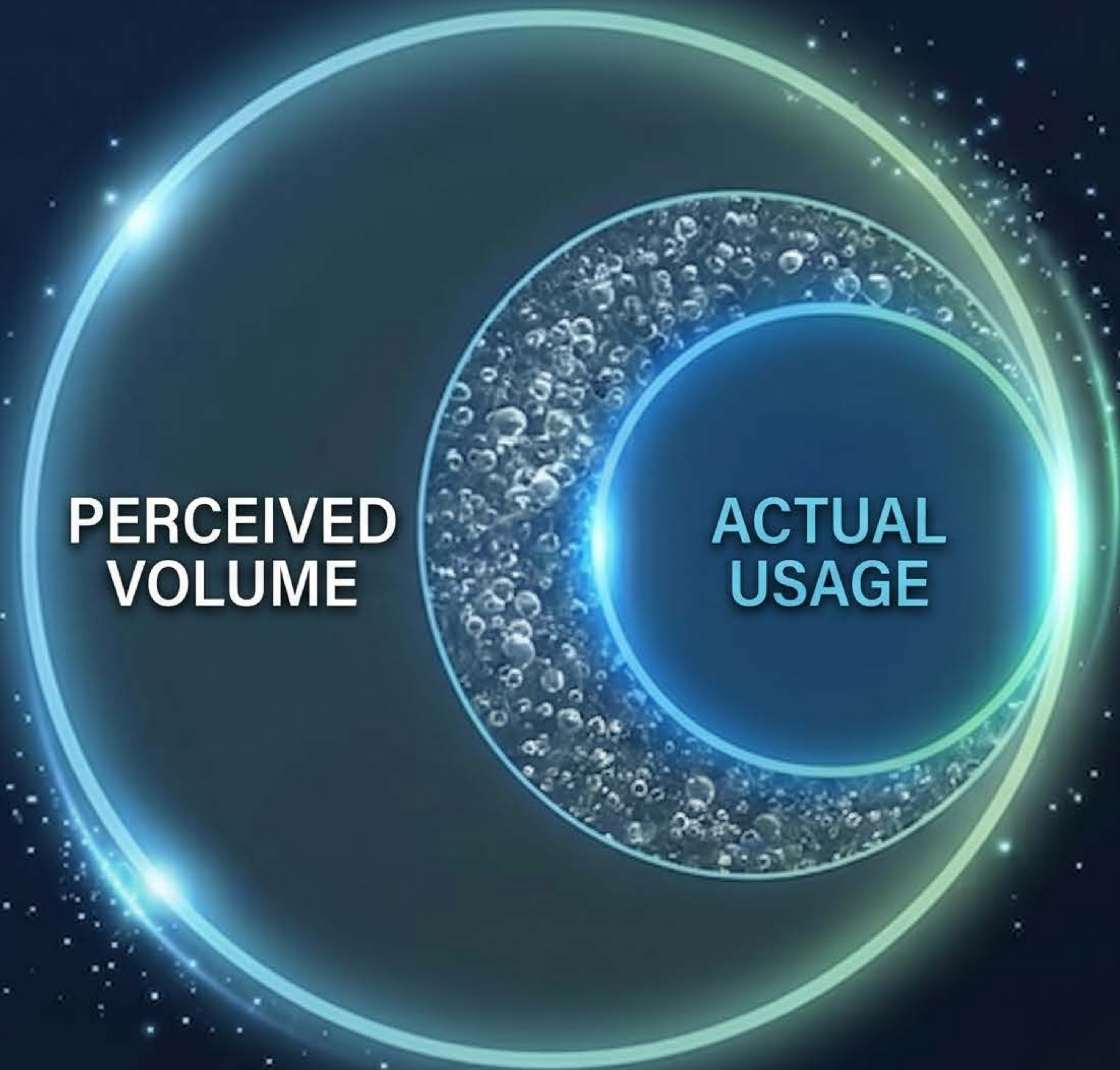

ACTUAL WATER BILLS DECREASE.

With an enhanced feel of abundant water, actual tap water consumption is significantly reduced.



CLEANING AGENT EXPENSES HALVED.

Physical cleaning power is enhanced, drastically reducing the required amount of dish soap and facial cleanser.

A Dual Revolution in Kitchen & Bathroom Purification.



KITCHEN APPLICATION: Food Safety Guardian

- ✔ Produce Washing: Deep into crevices to effectively remove bug eggs & pesticide residue.
- ✔ Dishwashing: Efficiently encapsulates grease; light greasiness removed with water alone.



BATHROOM APPLICATION: Lifesaver for Sensitive Skin

- ✔ Deep Skin Cleansing: Cleans more thoroughly than ordinary water, removing sweat & oil from deep within pores.
- ✔ Gentle Care: Reduces irritation from chemical detergents, extremely friendly to sensitive skin.

Create a Panoramic Micro-Bubble Smart Home Blueprint.



Kitchen Food Safety

Remove fishiness and pesticides, deeply decompose residual odors.



Bathroom Health

Suitable for sensitive skin, deep sterilization and deodorization, for more translucent skin.



Pet Health

Deeply clean pet fur, reduce dander and odors.



Laundry Room Application

Deeply penetrate fabric fibers, thorough sterilization and deodorization, for softer clothes.



Gardening Greenery

High oxygen for plants, promotes root absorption, for healthier plants.

Flexible Options, Perfect for Every Corner of Your Home.

Standard Microbubble Aerator

Model: AT886M/S



- Features: Minimalist stainless steel body, seamlessly integrates with existing designs.
- Suitable For: Fixed spouts, standard washbasins.

Swivel Microbubble Aerator Set

Model: AT886H/S



- Features: High-quality swivel joint for flexible 360-degree angle adjustment.
- Suitable For: Large kitchen sinks, work surfaces requiring all-around rinsing.

PRECISION SPECIFICATIONS, UPGRADE YOUR WATER USE EFFORTLESSLY IN 1 MINUTE.

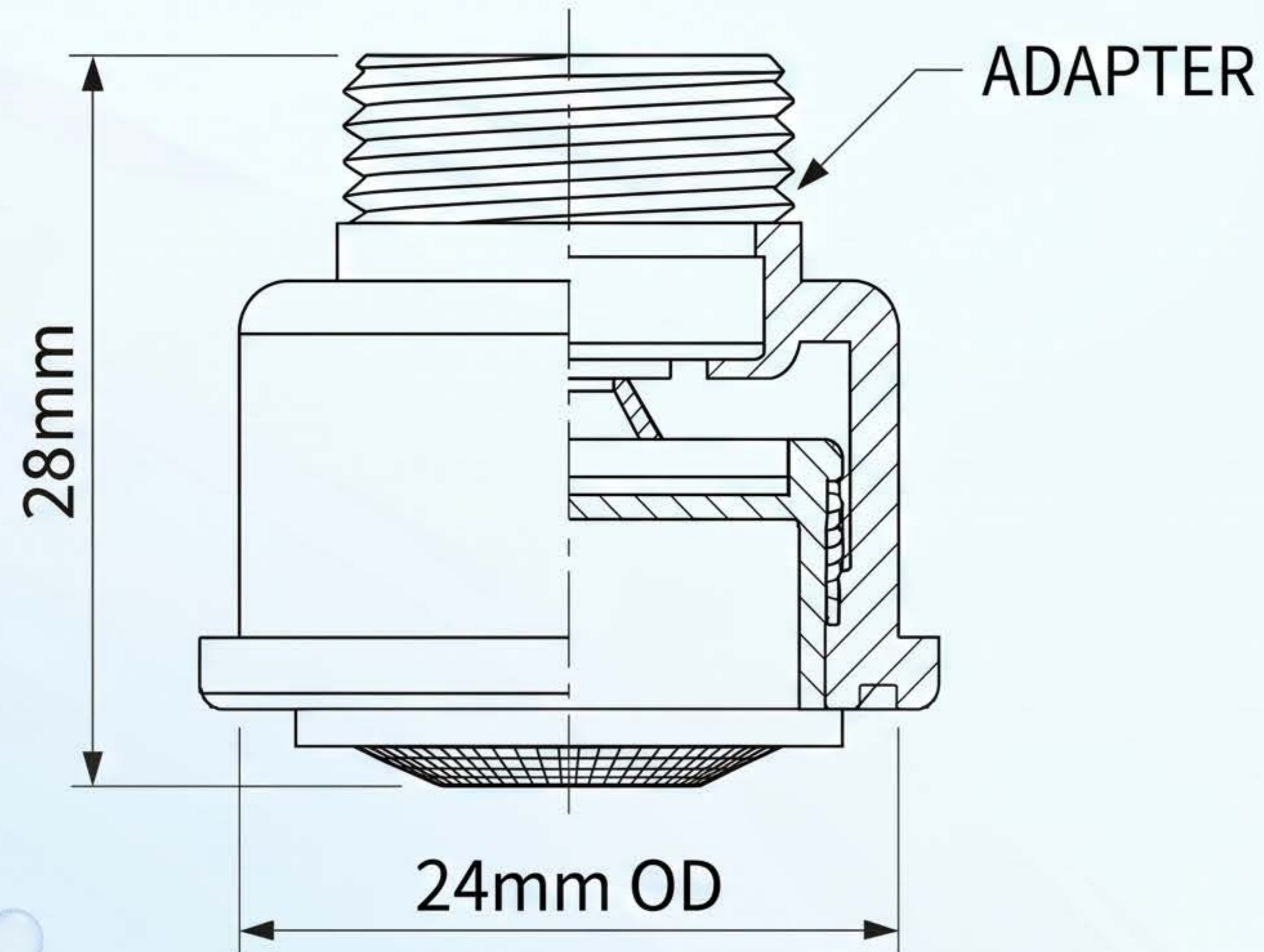

- ✓ Material: #304 Stainless Steel, Food-Grade PP Material
- ✓ Dimensions: 28 x 24(OD) mm
- ✓ Weight: Ultra-Light 30.3g (Including Adapter)
- ✓ Threads: Includes Universal 24 to 22 Male Thread Adapter (Compatible with most faucets on the market)



PROFESSIONAL REMINDER

- OPTIMAL OPERATING CONDITIONS: SUITABLE FOR WATER PRESSURE ABOVE 1.5kg/cm².
- WATER QUALITY REQUIREMENT: FOR CLEAN TAP WATER SYSTEMS ONLY, ENSURE PRECISE FILTER IS NOT CLOGGED, MAXIMIZE AERATION EFFICIENCY.

Swap to an Aerator, Elevate Health Water Standards for Your Entire Family.

The Strong Microbubble Sprite: Making every faucet turn a pure home SPA.

Add Official LINE for Immediate Consulation.



Taiwan Quality Microbubble Manufacturer | STRONG LTD.

Service Hotline : 886-4-2531-2575

Email : sales@strongltd.com.tw

LINE ID : @tfu4534l (小寫L)