

# Bring quality water into every micro-detail of life.

ERDEN AT886MS Microbubble Elf — Your Smart Water Upgrade Solution for the Home.



# Is water that looks clean truly purifying? Traditional water flow can't reach microscopic hidden spots.



Pesticides and dirt in deep crevices:  
Difficult for plain water to remove.



To remove oil, large amounts of  
chemical detergents are used,  
creating residual risks.



Water flow impact is too powerful,  
countertop can never stay dry.

# A Zero-Power Physical Miracle: Pure, Yet Incredibly Powerful.

AT886MS Core Components Revealed.

## Dual Purification

Precision Filter Mesh  
(Blocks Impurities, Refines Bubbles)



## Robust and Durable

#304 Stainless Steel & Food-Grade PP Materials.

## Innovation Driven

Pure Physical Air Suction Technology  
(Zero Power, No Consumables, No Secondary Pollution)

# ULTIMATE MICROSCOPIC SCALE FOR DEEP PORE PENETRATION.

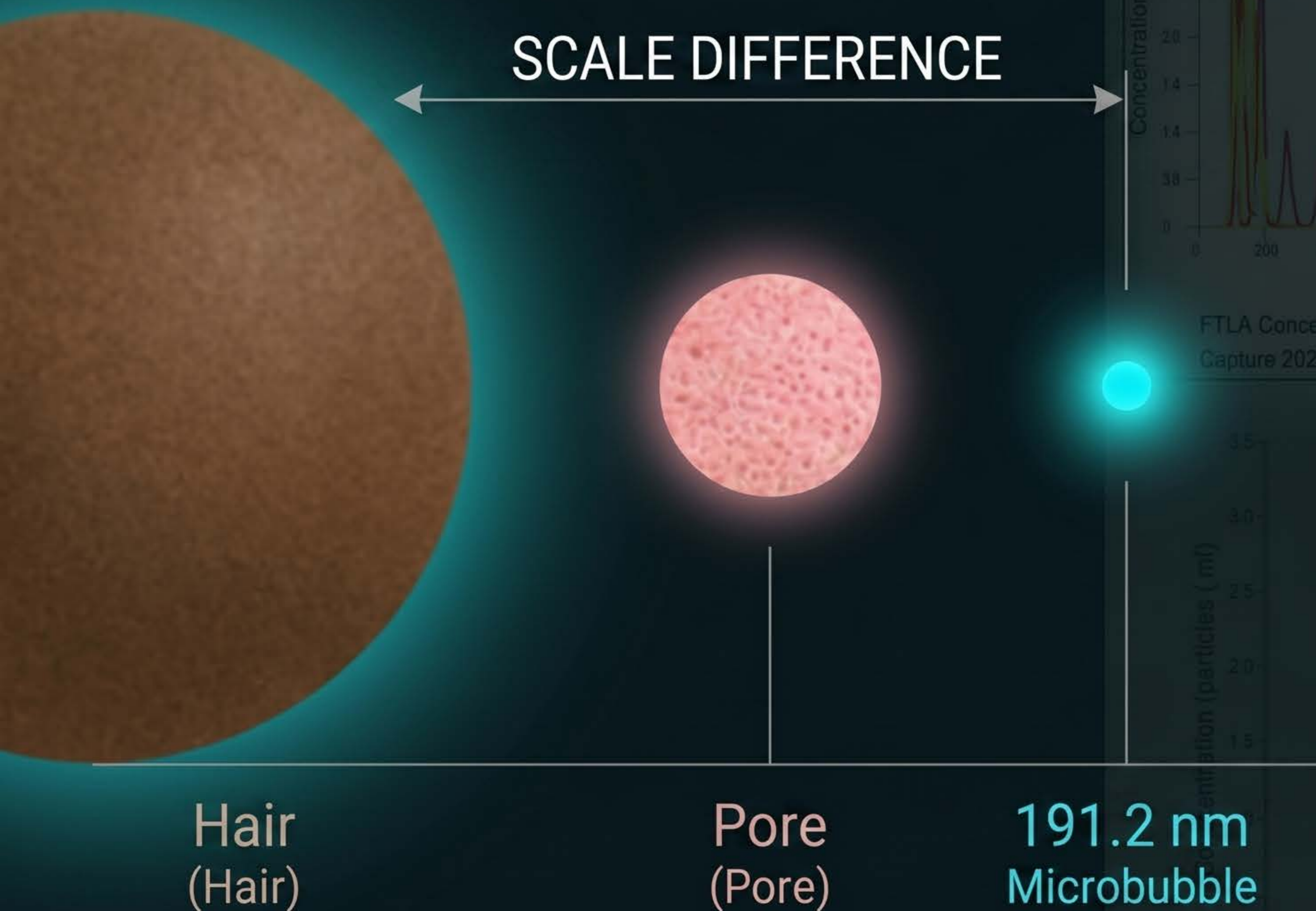

**191.2 nm**

AUTHORITATIVE DETECTION OF AVERAGE PARTICLE SIZE, HUNDREDS OF TIMES SMALLER THAN HUMAN BODY PORES.

**1.5 BILLION UNITS**

EACH MILLILITER (ml) OF WATER CONTAINS UP TO 153-216 MILLION CLEANSING SPIRITS.

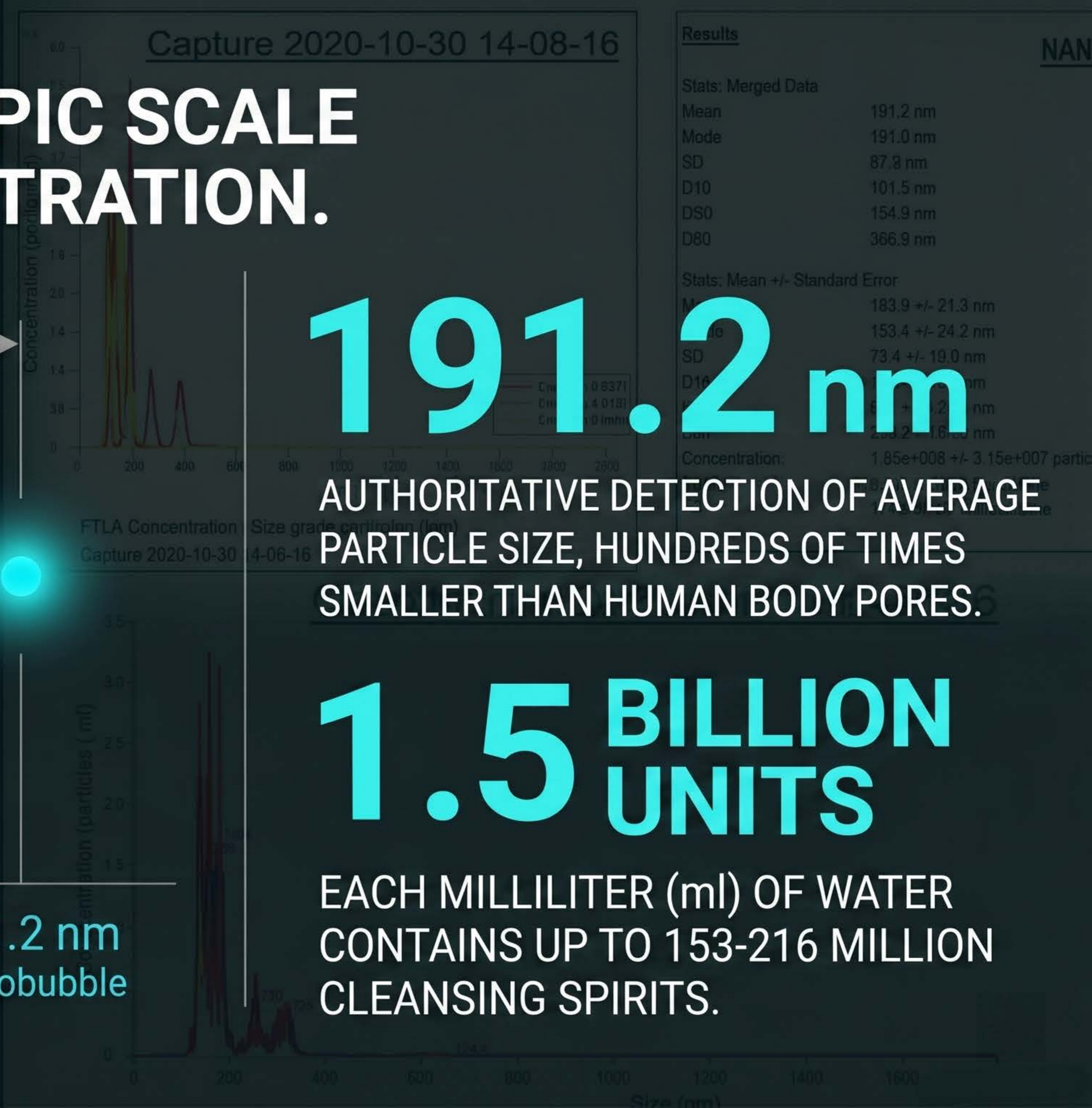

# Visible Bubbles, Hidden Grime.

## Standard Aerator

→ Large, easily burst bubbles.  
Transparent & colorless.



## Microbubble Cleanser

→ Hundreds of millions of dense,  
suspended nano-sized bubbles.

## Why does the water look milky?

This is the pure effect of light refraction by high-density microbubbles. No chemical additives. Letting it sit for a few minutes will make it gradually clear up from the bottom, returning it to its original pure water state.

# A Gentle Touch, Say Goodbye to Messy Splashing.

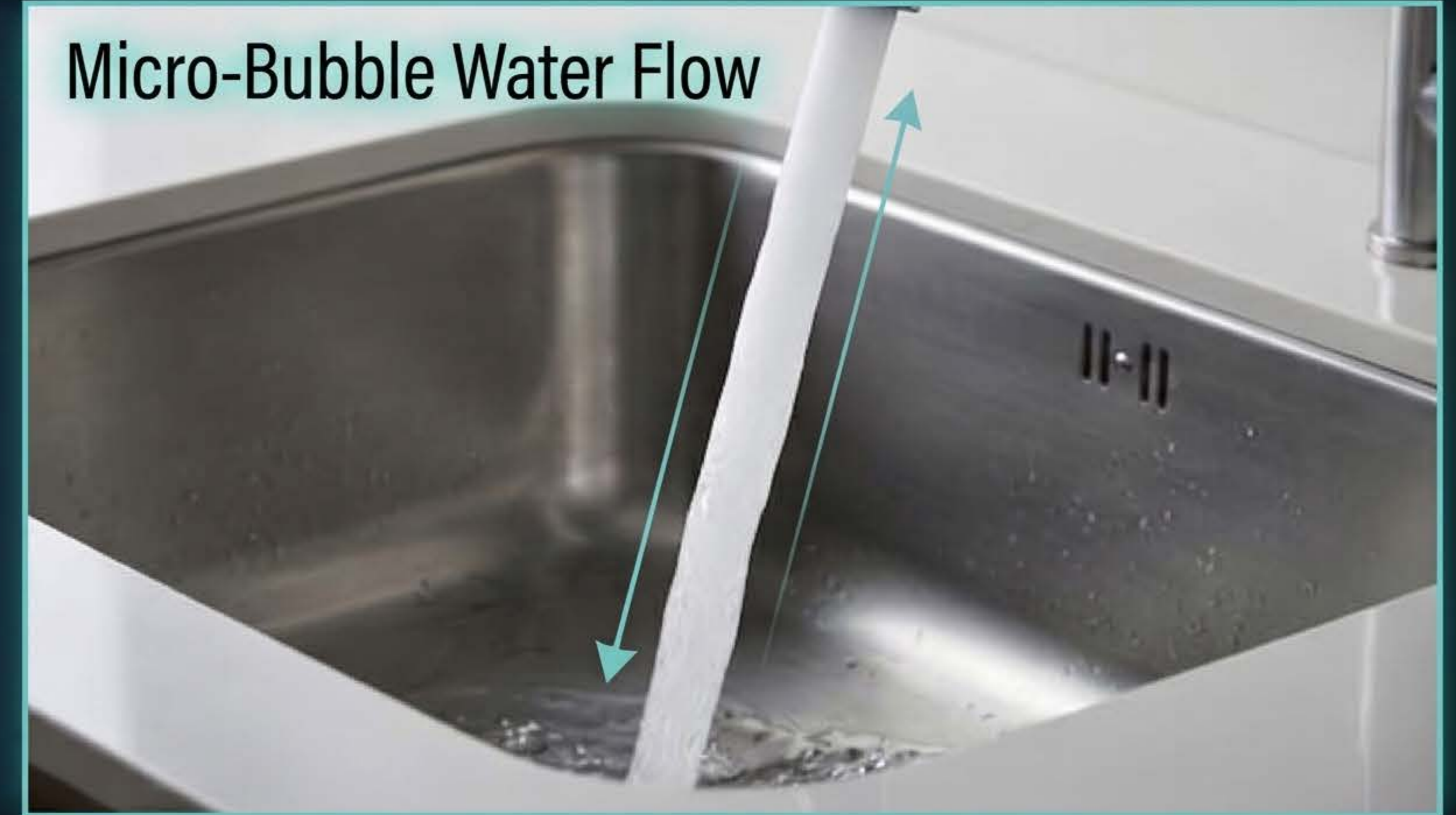

Traditional Water Flow

Excessive Force → Slippery Wet Surfaces, More Housework.

Micro-Bubble Water Flow

Dense & Fine → Reduced Splashes, Keeps Surfaces Dry.

## Every Hand Wash Feels Like a Gentle Micro-SPA.

# DEEP STRIPPING: The Physical Nemesis of Grease and Pesticides.

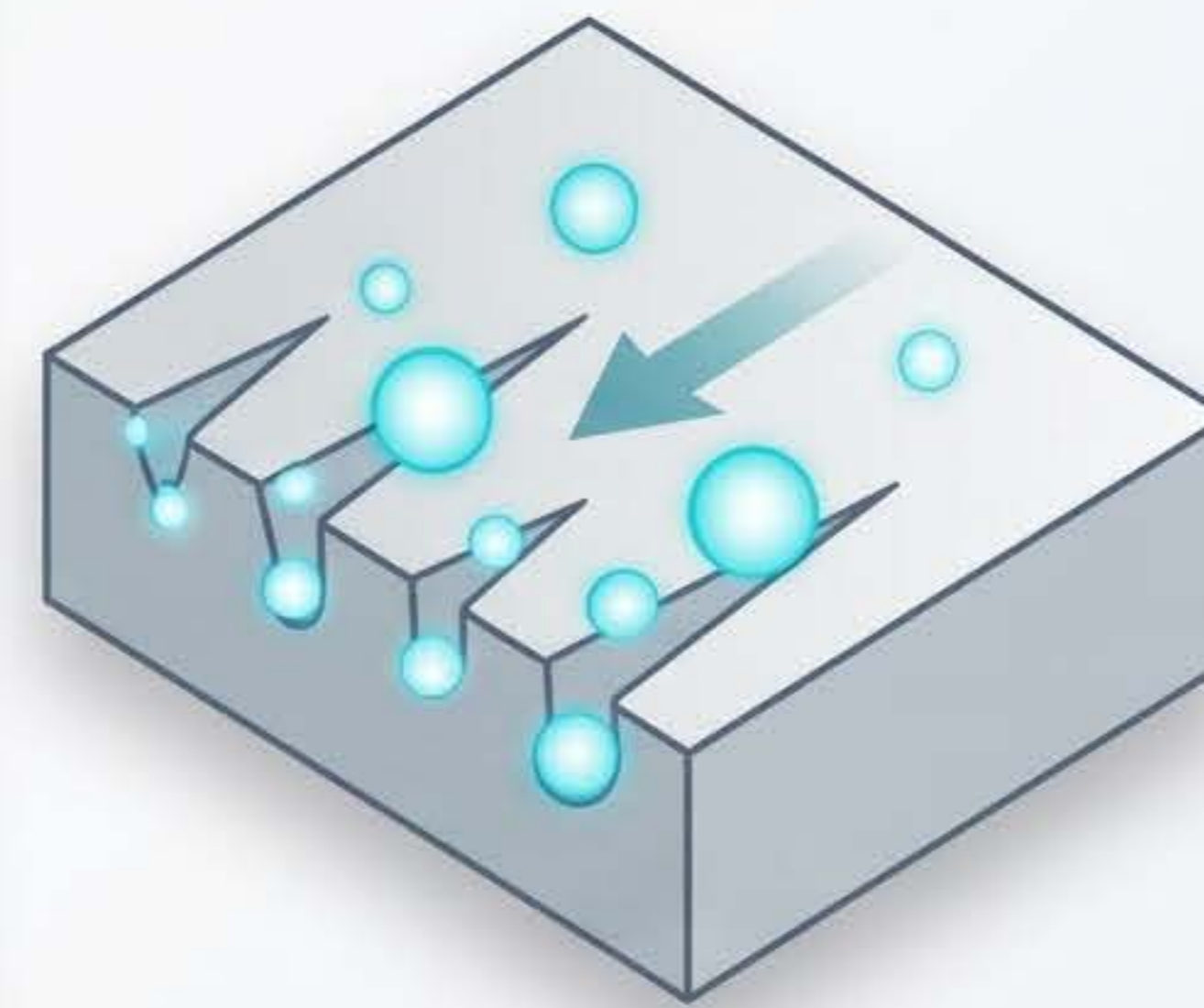

## 1 Deep Penetration

Nano-bubbles bore into recesses of produce and fine lines of tableware.



## 2 Adsorbing Contaminants

Bubble surface tension encapsulates grease, sediment, and pesticides.

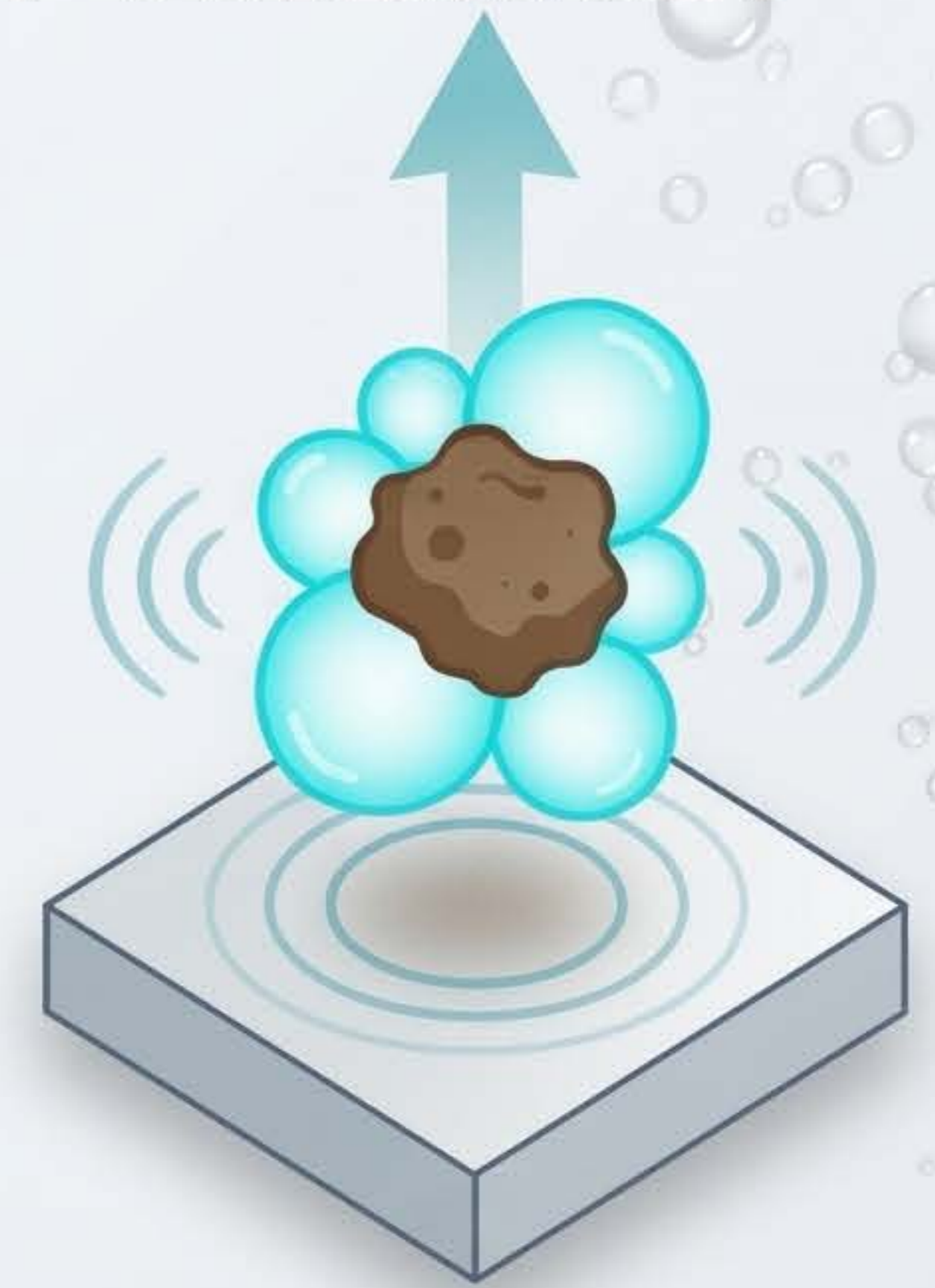

## 3 Effective Grime Removal

Instant micro-bubble collapse generates micro-waves to physically strip and carry away residues.

**Greatly Reduces Dish Detergent Usage,  
Entirely Bids Farewell to Chemical Residues,  
and Ensures Safer Family Dining.**

# GREEN ECONOMY: THE WIN-WIN SOLUTION WITH NO LOSS IN PERCEIVED VOLUME.

A large volume of micro-bubbles occupies the water flow, increasing the contact area and "Perceived Volume Richness".

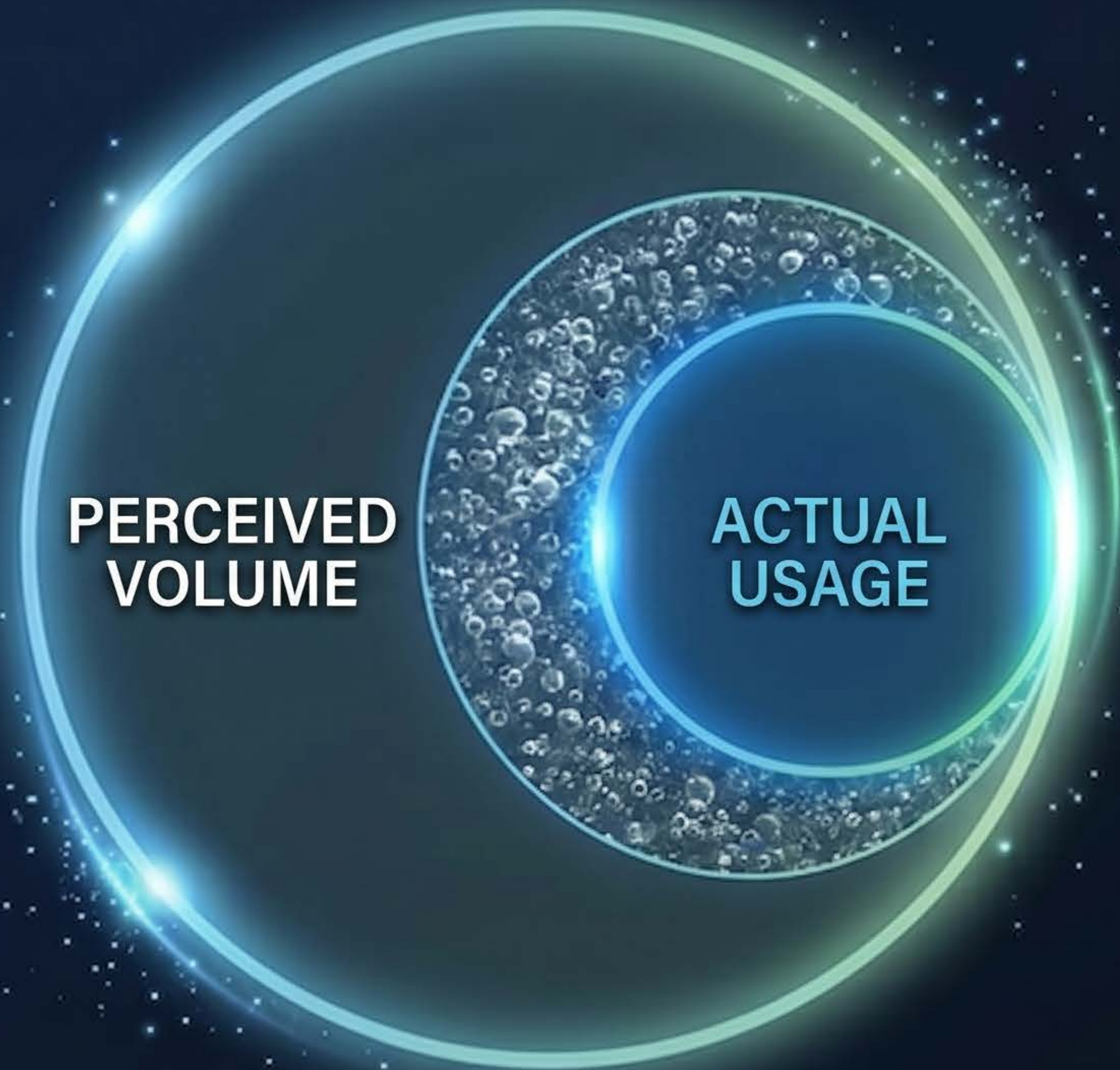

## ACTUAL WATER BILLS DECREASE.

With an enhanced feel of abundant water, actual tap water consumption is significantly reduced.



## CLEANING AGENT EXPENSES HALVED.

Physical cleaning power is enhanced, drastically reducing the required amount of dish soap and facial cleanser.

# A Dual Revolution in Kitchen & Bathroom Purification.



## KITCHEN APPLICATION: Food Safety Guardian

- ✔ Produce Washing: Deep into crevices to effectively remove bug eggs & pesticide residue.
- ✔ Dishwashing: Efficiently encapsulates grease; light greasiness removed with water alone.



## BATHROOM APPLICATION: Lifesaver for Sensitive Skin

- ✔ Deep Skin Cleansing: Cleans more thoroughly than ordinary water, removing sweat & oil from deep within pores.
- ✔ Gentle Care: Reduces irritation from chemical detergents, extremely friendly to sensitive skin.

# Create a Panoramic Micro-Bubble Smart Home Blueprint.



## Kitchen Food Safety

Remove fishiness and pesticides, deeply decompose residual odors.



## Bathroom Health

Suitable for sensitive skin, deep sterilization and deodorization, for more translucent skin.



## Laundry Room Application

Deeply penetrate fabric fibers, thorough sterilization and deodorization, for softer clothes.



## Gardening Greenery

High oxygen for plants, promotes root absorption, for healthier plants.



## Pet Health

Deeply clean pet fur, reduce dander and odors.

# Flexible Options, Perfect for Every Corner of Your Home.

## Standard Microbubble Aerator

Model: AT886M/S



- Features: Minimalist stainless steel body, seamlessly integrates with existing designs.
- Suitable For: Fixed spouts, standard washbasins.

## Swivel Microbubble Aerator Set

Model: AT886H/S



- Features: High-quality swivel joint for flexible 360-degree angle adjustment.
- Suitable For: Large kitchen sinks, work surfaces requiring all-around rinsing.

# PRECISION SPECIFICATIONS, UPGRADE YOUR WATER USE EFFORTLESSLY IN 1 MINUTE.

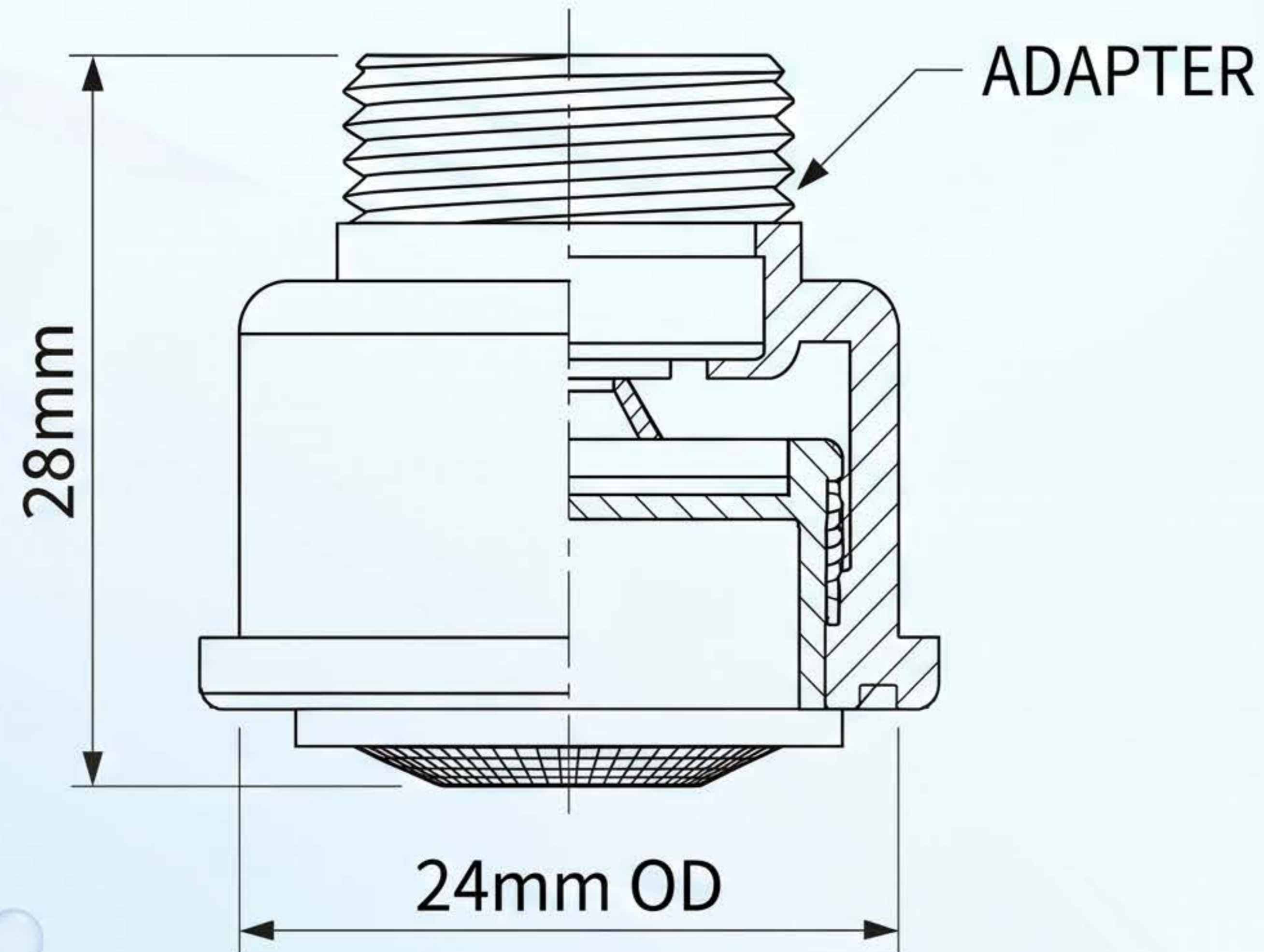

- ✓ Material: #304 Stainless Steel, Food-Grade PP Material
- ✓ Dimensions: 28 x 24(OD) mm
- ✓ Weight: Ultra-Light 30.3g (Including Adapter)
- ✓ Threads: Includes Universal 24 to 22 Male Thread Adapter (Compatible with most faucets on the market)



## PROFESSIONAL REMINDER

- OPTIMAL OPERATING CONDITIONS: SUITABLE FOR WATER PRESSURE ABOVE 1.5kg/cm<sup>2</sup>.
- WATER QUALITY REQUIREMENT: FOR CLEAN TAP WATER SYSTEMS ONLY, ENSURE PRECISE FILTER IS NOT CLOGGED, MAXIMIZE AERATION EFFICIENCY.

# Swap to an Aerator, Elevate Health Water Standards for Your Entire Family.

The Strong Microbubble Sprite: Making every faucet turn a pure home SPA.

Add Official LINE for Immediate Consultation.



Taiwan Quality Microbubble Manufacturer | STRONG LTD.

Service Hotline : 886-4-2531-2575

Email : sales@strongltd.com.tw

LINE ID : @tfu4534l (小寫L)